

LE4D09 - 35	A
Version standard / Standard version	182
Version A04 / A04 version	167
Version A05 / A05 version	175,5

LE4-D09 / D12 / D18 / D25 / D35

LE4-D	3 ~ 50/60 Hz AC3					lth max	LRD●●	 a M (A)
	380 400 V	415 V	440 V	500 V	660 690 V			
	kW	kW	kW	kW	kW			
09	1,5	1,5	1,5	2,2	—	9	08	6
	2,2	2,2	2,2	3,7	—	9	10	8
	4	4	4	5,5	—	9	14	6
12	5,5	5,5	5,5	7,5	—	12	16	16
18	7,5	9	9	10	—	18	21	16
25	11	—	—	—	—	25	22	25
35	15	15	15	18,5	—	35	32	32

LE4-D standard

Puissance / Power

Contrôle / Control LE4-D09 - D35 : C = 1,7 Nm
LE4-D09 - D25 LE4-D35

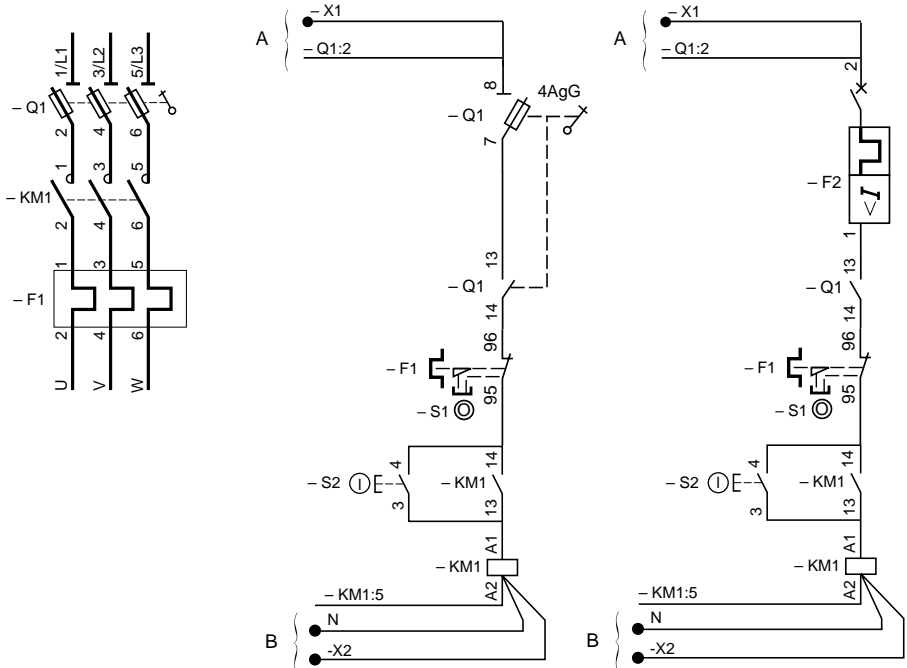

Raccordements / Connections

Tension bobine / Coil voltage		A	B
220 V, 230 V, 240 V	LE4-D09 - D35	Q1: 2	Borne N / Terminal N
380 V	LE4-D09 - D35	Q1: 2	KM1:5
Autres tensions / Other voltages	LE4-D09 - D35	Borne 1 / Terminal 1	Borne 2 / Terminal 2

LE4-D09 / D12 / D18 / D25 / D35

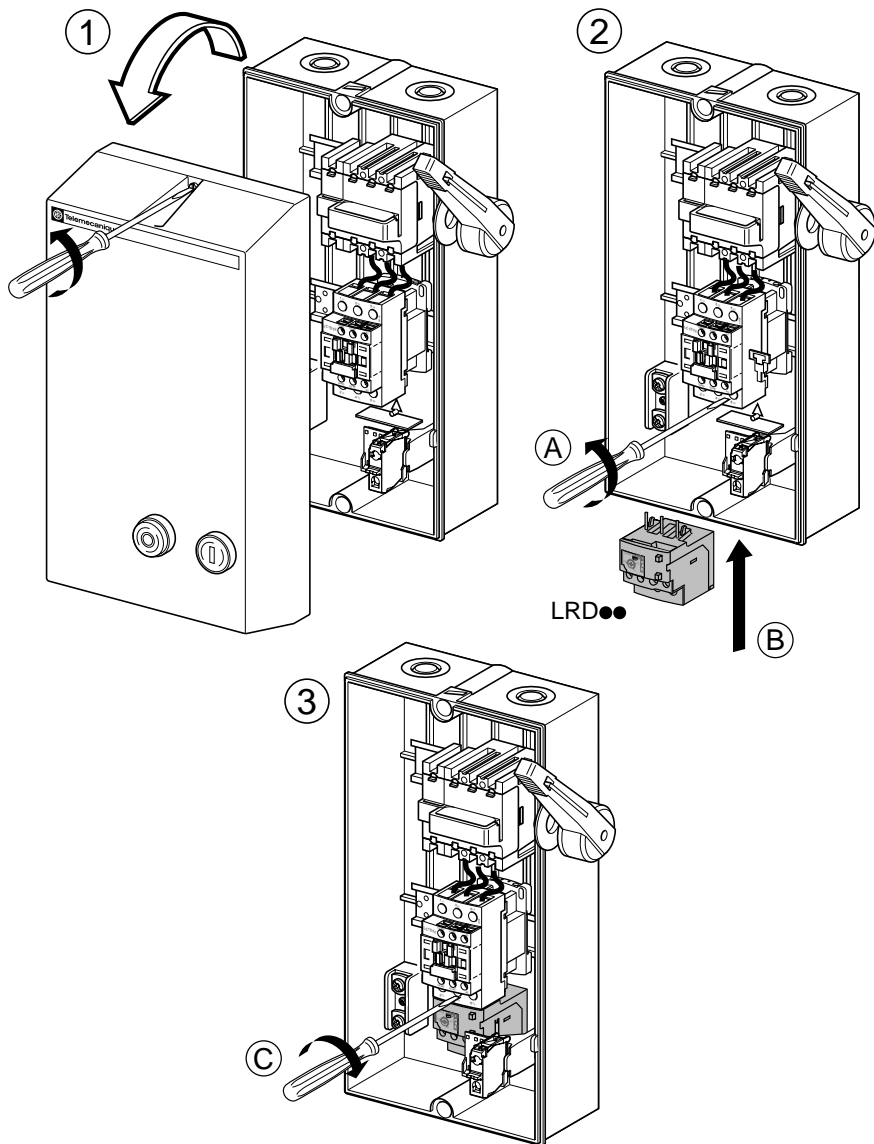

Montage relais/relay mounting :LE4-D09/12/18 :C = 1,7Nm.

LE4-D25/35 :C = 2,5Nm

Câblage relais/relay wiring : C = 2,5Nm

Câblage sectionneur/fuse carriers wiring :LE4-D09/12/18/25 :C = 1,2Nm.

LE4-D35 :C = 2Nm

LE4-D09 / D12 / D18 / D25 / D35

LE4-D09 - D25 A04

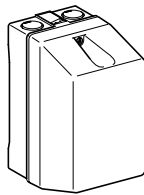
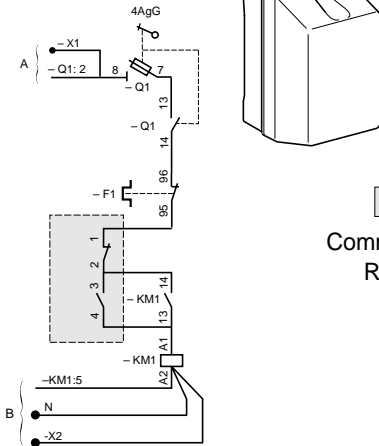

LE4-D09 - D25 A05

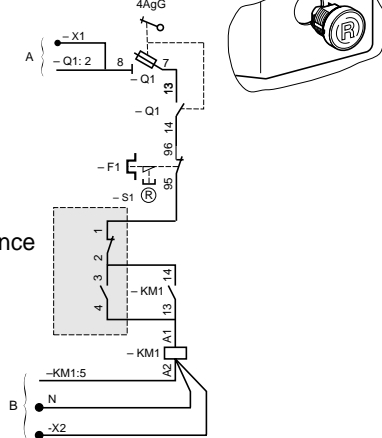

Commande à distance
Remote control

LE4-D35 A04

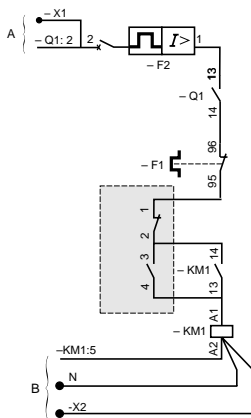

LE4-D35 A05

